

Chiavi a T snodate
bocca esagonale con snodo cardanico e asta frizionata
 acciaio al cromo vanadio - cromate UNI 6743
"T" handle hexagonal socket wrenches
with universal joint and friction bar

- Coppie di serraggio superiori ai valori stabiliti dalla norma ISO 1711-1 serie C.
- Angolo di rotazione delle bussole pari a 50°.
- Le molle elicoidali all'interno dello snodo garantiscono la posizione desiderata delle bussole.
- Asta di manovra scorrevole e frizionata permette di bloccarla in tutte le posizioni rispetto alla sua lunghezza.
- I fermi di sicurezza impediscono la fuoriuscita dell'asta.

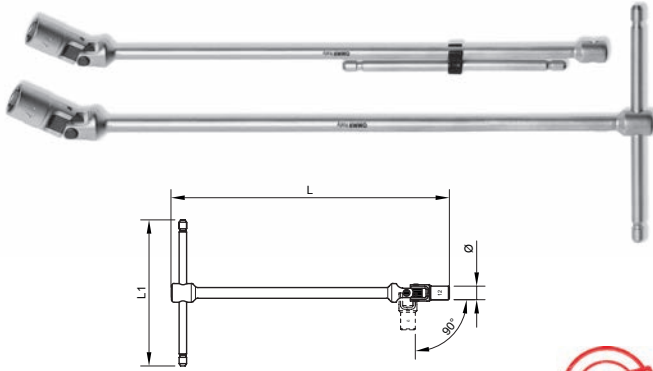

Cod.	⊙	L	ØxL1	Ø	⊞	⊞
25001RC	6	400	7x165	10	1	225
25002RC	7	400	7x165	11,6	1	225
25003RC	8	400	7x165	12,7	1	225
25004RC	9	400	7x165	14	1	225
25005RC	10	445	9x180	15	1	430
25006RC	11	445	9x180	16,8	1	430
25007RC	12	450	9x180	17,6	1	430
25008RC	13	450	9x180	19,2	1	430
25009RC	14	450	9x180	20,6	1	430
25010RC	15	480	9x180	22	1	600
25011RC	16	480	9x180	23,1	1	600
25012RC	17	480	9x180	24,3	1	600
25013RC	18	480	9x180	25	1	600
25014RC	19	510	11x230	26,3	1	930
25015RC	20	510	11x230	27,5	1	930
25016RC	21	510	11x230	28,8	1	930
25017RC	22	510	11x230	30,7	1	930
25018RC	24	515	11x230	33	1	930

Serie 7 chiavi a T snodate
bocca esagonale con snodo cardanico e asta frizionata
 acciaio al cromo vanadio - cromate
7 pcs "T" handle hexagonal socket wrench set



Cod.	Pz./Pcs.	⊞	⊞
25000RC/7	7	1	2700

Composizione:
 mm 7-8-10-12-13-14-17

Chiavi a T snodate
esagono maschio con snodo cardanico e asta frizionata
 acciaio al cromo vanadio - cromate - bussole fosfatate.
"T" handle wrenches with universal joint hexagonal head
and friction bar

- Coppie di serraggio superiori ai valori stabiliti dalla norma ISO 1711-1 serie C.
- Angolo di rotazione delle bussole pari a 50°.
- Le molle elicoidali all'interno dello snodo garantiscono la posizione desiderata delle bussole.
- Asta di manovra scorrevole e frizionata permette di bloccarla in tutte le posizioni rispetto alla sua lunghezza.
- I fermi di sicurezza impediscono la fuoriuscita dell'asta.

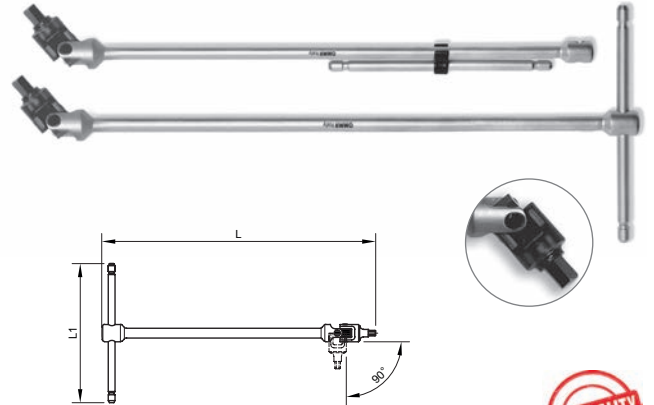

Cod.	⊙	L	ØxL1	⊞	⊞
26002RC	3	395	7x165	1	220
26004RC	4	395	7x165	1	220
26006RC	5	395	7x165	1	225
26007RC	6	445	9x180	1	430
26009RC	8	445	9x180	1	430
26010RC	10	480	9x180	1	600

Chiavi a T snodate
inserto maschio per viti TX con snodo cardanico
 asta frizionata acciaio al cromo vanadio - cromate - bussole fosfatate.
"T" handle wrenches male head for Star screws
with universal joint and friction bar

- Coppie di serraggio superiori ai valori stabiliti dalla norma ISO 1711-1 serie C.
- Angolo di rotazione delle bussole pari a 50°.
- Le molle elicoidali all'interno dello snodo garantiscono la posizione desiderata delle bussole.
- Asta di manovra scorrevole e frizionata permette di bloccarla in tutte le posizioni rispetto alla sua lunghezza.
- I fermi di sicurezza impediscono la fuoriuscita dell'asta.

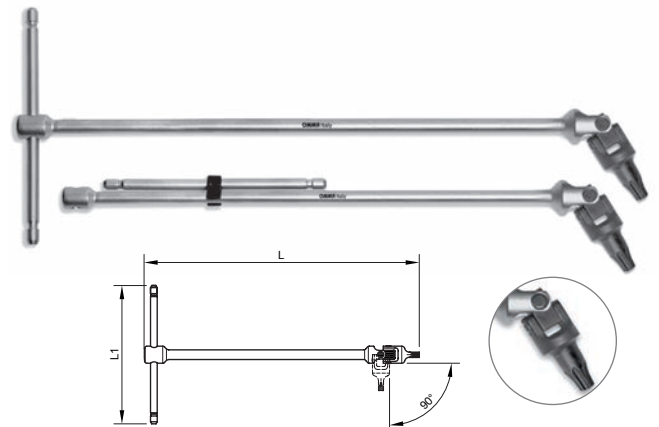

Cod.	⊙	L	ØxL1	⊞	⊞
26012TRC	20	400	7x165	1	223
26013TRC	25	400	7x165	1	223
26014TRC	27	400	7x165	1	223
26015TRC	30	450	9x180	1	421
26016TRC	40	450	9x180	1	421
26017TRC	45	450	9x180	1	421
26018TRC	50	480	9x180	1	593
26019TRC	55	480	9x180	1	593

Chiavi a T snodate - 1/4"
quadro maschio con snodo cardanico e asta frizionata
 acciaio al cromo vanadio - cromate
1/4" - T handle wrenches with universal joint

1/4"

- Coppie di serraggio superiori ai valori stabiliti dalla norma ISO 1711-1 serie C.
- Angolo di rotazione delle bussole pari a 50°.
- Due molle elicoidali all'interno dello snodo garantiscono la posizione desiderata delle bussole.
- Asta di manovra scorrevole e frizionata permette di bloccarla in tutte le posizioni rispetto alla sua lunghezza.
- I fermi di sicurezza impediscono la fuoriuscita dell' asta.

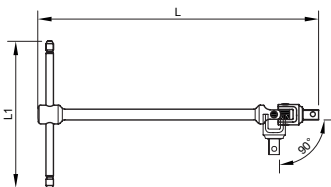

Cod.	■	L	ØxL1		
20776RC	1/4"	395	7x165	1	221

Chiavi a T snodate - 3/8"
quadro maschio con snodo e asta frizionata
 acciaio al cromo vanadio - cromate
3/8" - T handle wrenches with universal joint

3/8"

- Coppie di serraggio superiori ai valori stabiliti dalla norma ISO 1711-1 serie C.
- Angolo di rotazione delle bussole pari a 50°.
- Due molle elicoidali all'interno dello snodo garantiscono la posizione desiderata delle bussole.
- Asta di manovra scorrevole e frizionata permette di bloccarla in tutte le posizioni rispetto alla sua lunghezza.
- I fermi di sicurezza impediscono la fuoriuscita dell' asta.

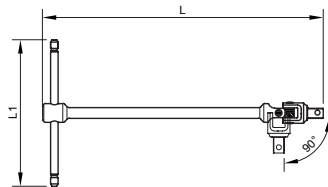

Cod.	■	L	ØxL1		
20076RC	3/8"	445	9x180	1	450

Chiavi a T snodata con 7 bussole esagonali - 1/4"
 acciaio al cromo vanadio - cromate
1/4" - T handle wrench with universal joint and square drive sockets 6 points

1/4"

- Coppie di serraggio superiori ai valori stabiliti dalla norma ISO 1711-1 serie C.
- Angolo di rotazione delle bussole pari a 50°.
- Due molle elicoidali all'interno dello snodo garantiscono la posizione desiderata delle bussole.
- Asta di manovra scorrevole e frizionata permette di bloccarla in tutte le posizioni rispetto alla sua lunghezza.
- I fermi di sicurezza impediscono la fuoriuscita dell' asta.

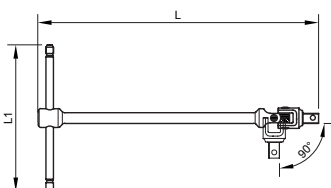

Cod.	Pz/Pcs		
20776RC/8	8	1	320

Composizione:
 1 chiave a T con attacco quadro snodato 1/4"
 7 bussole mm 5-5,5-6-7-8-9-10

Chiavi a T snodate - 1/2"
quadro maschio con snodo e asta frizionata
 acciaio al cromo vanadio - cromate
1/2" - T handle wrenches with universal joint

1/2"

- Coppie di serraggio superiori ai valori stabiliti dalla norma ISO 1711-1 serie C.
- Angolo di rotazione delle bussole pari a 50°.
- Due molle elicoidali all'interno dello snodo garantiscono la posizione desiderata delle bussole.
- Asta di manovra scorrevole e frizionata permette di bloccarla in tutte le posizioni rispetto alla sua lunghezza.
- I fermi di sicurezza impediscono la fuoriuscita dell' asta.

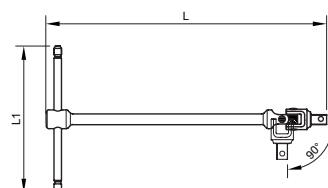

Cod.	■	L	ØxL1		
21076RC	1/2"	505	11x230	1	905
21076LRC	1/2"	1100	11x230	1	1910

Chiavi a T snodate per candele con snodo cardanico e asta frizionata
acciaio al cromo vanadio - cromate.
Spark plug wrenches with universal joint and friction bar

- Coppie di serraggio superiori ai valori stabiliti dalla norma ISO 1711-1 serie C.
- Angolo di rotazione delle bussole pari a 50°.
- Le molle elicoidali all'interno dello snodo garantiscono la posizione desiderata delle bussole.
- Asta di manovra scorrevole e frizionata permette di bloccarla in tutte le posizioni rispetto alla sua lunghezza.
- I fermi di sicurezza impediscono la fuoriuscita dell' asta.

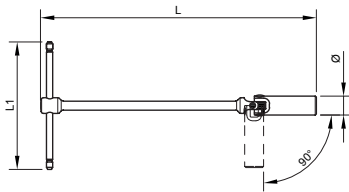

Cod.	Ø	L	ØxL1	Ø	📄	🔧
27011RC	14	485	9x180	19	1	500
27012RC	16	500	9x180	22	1	600
27013RC	18	525	9x180	24,5	1	700
27013A/RC	19	525	9x180	24,5	1	700
27014RC	20,8	525	11x230	27	1	965

Chiave a T snodata bocca esagonale con snodo cardanico e asta frizionata per inserti da 1/4"
acciaio al cromo vanadio - cromate.
"T" handle hexagonal socket wrench with universal joint and friction bar for 1/4" bits

- Angolo di rotazione delle bussole pari a 50°.
- Due molle elicoidali all'interno dello snodo garantiscono la posizione desiderata delle bussole.
- Asta di manovra scorrevole e frizionata permette di bloccarla in tutte le posizioni rispetto alla sua lunghezza.
- I fermi di sicurezza impediscono la fuoriuscita dell' asta.
- Bussola aggancio rapido dell'inserto.

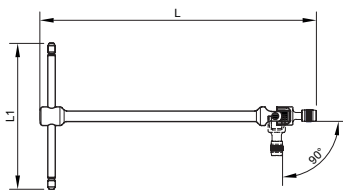

1/4"



Cod.	Ø	L	ØxL1	📄	🔧
25024FC	6,35	445	9x180	1	415

Chiavi a T bocca esagonale - UNI 6742 DIN 3112
acciaio al cromo molibdeno - cromate
Asta di manovra scorrevole.
I fermi di sicurezza impediscono la fuoriuscita dell' asta.
"T" handle hexagonal socket wrenches

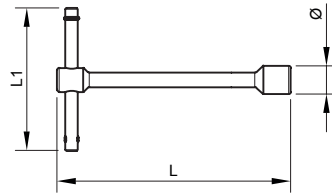

Cod.	Ø	L	ØxL1	Ø	📄	🔧
24221	6	215	7x165	10	1	140
24222	7	215	7x165	11,5	1	140
24223	8	230	7x165	12,5	1	150
24224*	9	230	7x165	14	1	155
24225	10	240	9x180	15,5	1	260
24226*	11	240	9x180	16,5	1	270
24227	12	260	9x180	17,5	1	315
24228	13	260	9x180	19,5	1	315
24229	14	280	10x220	20,5	1	430
24230*	15	280	10x220	22	1	430
24231*	16	280	10x220	23	1	440
24232	17	280	12x240	24,5	1	610
24234	19	300	12x240	27	1	650
24235*	20	300	12x240	28	1	750
24237	22	310	14x300	31	1	950

* IN ESAURIMENTO

Serie 7 chiavi a T bocca esagonale
acciaio al cromo molibdeno - cromate
UNI 6742 DIN 3112
7 pcs. T handle hexagonal socket wrench set



Cod.	Pz./Pcs.	📄	🔧
24220/7	7	1	2480

Composizione:
mm 7-8-10-12-13-17-19

Chiavi a T doppio esagono per dadi ruote autocarri

acciaio al cromo vanadio - cromate.

"T" wheel nut wrenches for trucks

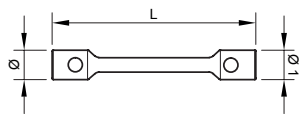

Cod.	○x○	Ø - Ø1	L		
26072	27x30	40 - 46	370	1	1500
26074	30x32	49 - 49	370	1	2000
26075	32x33	49 - 49	370	1	2000

Aste di manovra per Cod. 26072 ÷ 26075

con fermo di sicurezza

acciaio al carbonio - cromate.

Tommy bars for wheel nut truck wrenches

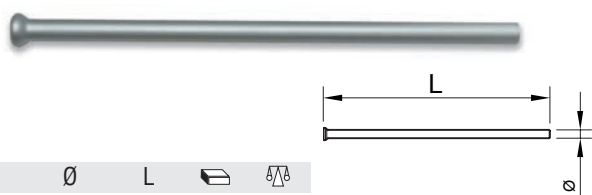

Cod.	Ø	L		
26111	22	600	1	1820

Chiave a croce per dadi ruote auto

acciaio al carbonio, cromata

Four way wheel nuts for cars



Cod.	mm		
26302	17x19x22x1/2"	1	1030

LINEA BASIC

Chiave a T multifunzione per bussole ed inserti da 1/4"

con asta scorrevole e dispositivo per avvitamanti rapidi

acciaio al cromo vanadio fosfatata.

Multi functional T wrench for 1/4" sockets and bits with sliding bar and device for fast screwings



Cod.	●	L	L1	Ø		
22300	6,35	210	120	14	1	230

Chiavi a T tre teste maschio esagonale

acciaio al cromo vanadio - cromate

punte brunite fino a mm 7

"T" hexagonal head wrenches

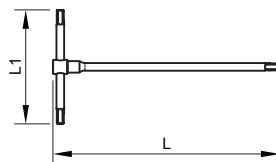

Cod.	●	L	L1		
31601	2	125	65	6	25
31602	2,5	125	65	6	25
31603	3	135	65	6	25
31604	3,5	135	65	6	25
31605	4	180	90	6	65
31606	4,5	180	90	6	65
31607	5	180	90	6	65
31608	6	210	105	6	140
31609	7	210	105	6	140
31610	8	250	125	6	240
31611	9	300	145	6	415
31612	10	300	145	6	415
31613	12	320	160	1	610
31615	14	340	170	1	840

Serie 6 chiavi a T tre teste maschio esagonale

acciaio al cromo vanadio - cromate punte brunite fino a mm. 7

"T" hexagonal head wrench set



Cod.	Pz./Pcs.		
31600/6	6	1	410

Composizione: ●
mm 2-2,5-3-4-5-6

Chiavi a T tre teste maschio esagonale - asta scorrevole con blocco antisfilamento
acciaio al cromo vanadio - cromate punte brunite fino a mm 14
"T" hexagonal head wrenches with sliding bar

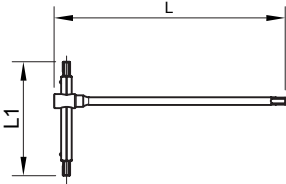
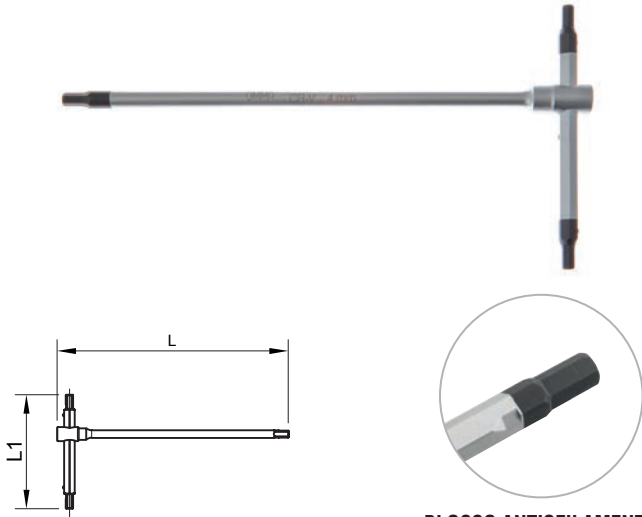

BLOCCO ANTISFILAMENTO

Cod.	●	L	L1	☞	☞
31601T	2	125	65	6	19
31602T	2,5	125	65	6	19
31603T	3	135	65	6	24
31605T	4	180	90	6	62
31607T	5	180	90	6	64
31608T	6	210	105	6	135
31610T	8	250	125	4	200
31612T	10	300	145	1	410
31613T	12	320	170	1	590
31615T	14	340	170	1	830

Serie 6 chiavi a T tre teste maschio esagonale - asta scorrevole con blocco antisfilamento
acciaio al cromo vanadio - cromate - punte brunite
"T" hexagonal head wrench with sliding bar set



Cod.	Pz./Pcs.	☞	☞
31600T/6	6	1	440

Composizione: ●
mm 2-2,5-3-4-5-6

BLOCCO ANTISFILAMENTO

Chiavi due teste maschio esagonale piegate con impugnatura ergonomica
acciaio al cromo vanadio - nichelate impugnatura in bi-componente
Hexagonal head wrenches

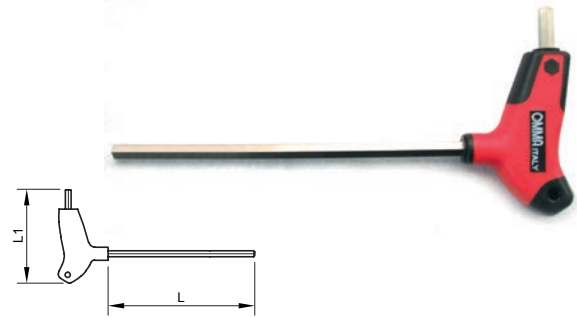

Cod.	●	L	L1	☞	☞
31321BIC	2	100	75	6	30
31322BIC	2,5	100	75	6	33
31323BIC	3	100	75	6	36
31325BIC	4	148	95	6	70
31327BIC	5	148	95	6	85
31329BIC	6	148	95	6	102
31331BIC	8	190	113	4	195
31333BIC	10	190	115	4	267

Serie 6 chiavi due teste maschio esagonale piegate con impugnatura ergonomica
acciaio al cromo vanadio - nichelate impugnatura in bi-componente
Hexagonal head wrench set

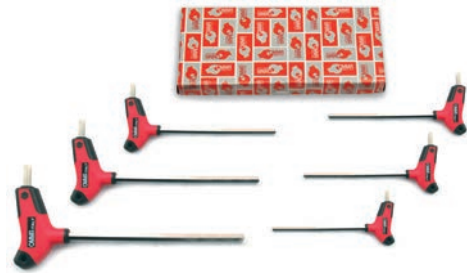

Cod.	Pz./Pcs.	☞	☞
31320BIC/6	6	1	368

Composizione: ●
mm 2-2,5-3-4-5-6

Chiavi due teste maschio esagonale piegate con testa sferica con impugnatura ergonomica
acciaio al cromo vanadio - nichelate impugnatura in bi-componente
Hexagonal ball point T handle key wrenches

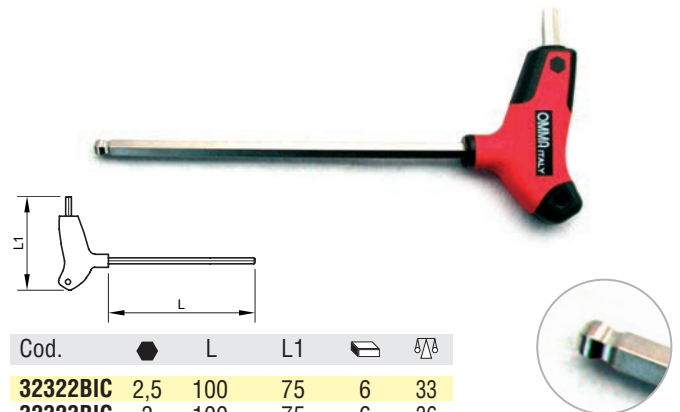

Cod.	●	L	L1	☞	☞
32322BIC	2,5	100	75	6	33
32323BIC	3	100	75	6	36
32324BIC	4	148	95	6	70
32325BIC	5	148	95	6	85
32327BIC	6	148	95	6	102
32329BIC	8	190	113	4	195
32330BIC	10	190	115	4	267

Serie 5 chiavi due teste maschio esagonale piegate con testa sferica con impugnatura ergonomica
acciaio al cromo vanadio - nichelate - impugnatura in bi-componente
Hexagonal ball point T handle key wrench set

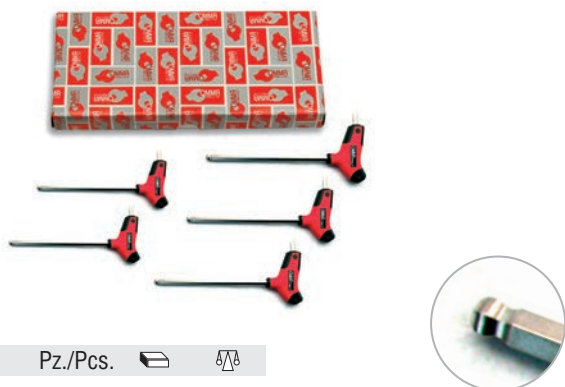

Cod.	Pz./Pcs.		
32320BIC/5	5	1	350

Composizione:
mm 2,5-3-4-5-6

Chiavi a due teste per viti TX piegate con impugnatura ergonomica
acciaio al cromo vanadio - nichelate impugnatura in bi-componente
Star T handle key wrenches



Cod.		L	L1		
34404BIC	T08	100	75	6	38
34405BIC	T09	100	75	6	39
34406BIC	T10	100	75	6	39
34407BIC	T15	100	95	6	64
34408BIC	T20	100	95	6	64
34409BIC	T25	148	95	6	81
34410BIC	T27	148	95	6	81
34411BIC	T30	148	95	6	96
34412BIC	T40	190	113	4	156
34413BIC	T45	190	113	4	182
34414BIC	T50	190	113	4	214

Serie 5 chiavi a due teste per viti TX piegate con impugnatura ergonomica
acciaio al cromo vanadio - nichelate impugnatura in bi-componente
Star T handle key wrench set



Cod.	Pz./Pcs.		
34400BIC/5	5	1	350

Composizione:
T15-T20-T25-T27-T30

Serie 7 chiavi a due teste per viti TX piegate con impugnatura ergonomica
acciaio al cromo vanadio - nichelate impugnatura in bi-componente
Star T handle key wrench set



Cod.	Pz./Pcs.		
34400BIC/7	7	1	648

Composizione:
T10-T15-T20-T25-T27-T30-T40

Chiavi fisse a due bocche UNI-ISO 10102 DIN 3110 "OMMA Italy"
acciaio al cromo vanadio - cromate
Double open ended wrenches
UNI-ISO 10102 DIN 3110 "OMMA Italy"



Cod.	mm			
11001	6x7	125	10	25
11002	8x9	140	10	35
11003	10x11	155	10	60
11004	12x13	172	10	75
11005	14x15	188	10	90
11006	16x17	205	10	130
11007	18x19	220	10	180
11008	20x22	235	5	215
11009	21x23	248	5	225
11010	24x27	265	5	340
11011	25x28	282	5	350
11013	30x32	300	5	470



Serie 8 chiavi fisse a due bocche UNI-ISO 10102 DIN 3110 "OMMA Italy"
acciaio al cromo vanadio - cromate
Double open ended wrench set UNI-ISO 10102 DIN 3110 "OMMA Italy"



Cod.	Pz./Pcs.		
11100	8	1	840

Composizione:
6x7-8x9-10x11-12x13-14x15-16x17-18x19-20x22



**Serie 8 chiavi fisse a due bocche
UNI-ISO 10102 DIN 3110 "OMMA Italy"**
acciaio al cromo vanadio - cromate - in borsa richiudibile - appendibile
Double open ended wrench set UNI-ISO 10102 DIN 3110 "OMMA Italy"



Cod.	Pz./Pcs.		
11101	8	1	800



Composizione:
6x7-8x9-10x11-12x13-14x15-16x17-18x19-20x22

**Serie 12 chiavi fisse a due bocche
UNI-ISO 10102 DIN 3110 "OMMA Italy"**
acciaio al cromo vanadio - cromate
Double open ended wrench set UNI-ISO 10102 DIN 3110 "OMMA Italy"



Cod.	Pz./Pcs.		
11200	12	1	2250

Composizione:
6x7-8x9-10x11-12x13-14x15-16x17-18x19-20x22-21x23-24x27-25x28-30x32

**Serie 12 chiavi fisse a due bocche
UNI-ISO 10102 DIN 3110 "OMMA Italy"**
acciaio al cromo vanadio - cromate - in borsa richiudibile - appendibile
Double open ended wrench set UNI-ISO 10102 DIN 3110 "OMMA Italy"



Cod.	Pz./Pcs.		
11102	12	1	2320



Composizione:
6x7-8x9-10x11-12x13-14x15-16x17-18x19-20x22-21x23-24x27-25x28-30x32

Chiavi fisse a due bocche UNI-ISO 10102 DIN 3110
acciaio al cromo vanadio - satinato
Double open ended wrenches UNI-ISO 10102 DIN 3110



Cod.	mm			
11501	6x7	122	10	30
11502	8x9	140	10	40
11503	10x11	157	10	50
11504	12x13	172	10	70
11505	14x15	185	10	100
11506	16x17	205	10	125
11507	18x19	222	10	180
11508	20x22	236	5	240
11509	21x23	245	5	250
11510	24x27	266	5	350
11511	25x28	280	5	380
11511/29	27x29	280	5	450
11512	30x32	302	5	525

Serie 8 chiavi fisse a due bocche UNI-ISO 10102 DIN 3110
acciaio al cromo vanadio - satinato
Double open ended wrench set UNI-ISO 10102 DIN 3110



Cod.	Pz./Pcs.		
11520	8	1	880

Composizione:
6x7-8x9-10x11-12x13-14x15-16x17-18x19-20x22

Serie 8 chiavi fisse a due bocche UNI-ISO 10102 DIN 3110
acciaio al cromo vanadio - satinato - in borsa richiudibile - appendibile
Double open ended wrench set UNI-ISO 10102 DIN 3110

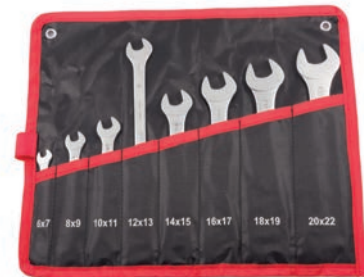

Cod.	Pz./Pcs.		
11401	8	1	920





Composizione:
6x7-8x9-10x11-12x13-14x15-16x17-18x19-20x22

Serie 12 chiavi fisse a due bocche UNI-ISO 10102 DIN 3110

acciaio al cromo vanadio - satinato

Double open ended wrench set UNI-ISO 10102 DIN 3110



Cod.	Pz./Pcs.		
11530	12	1	2400

Composizione:



6x7-8x9-10x11-12x13-14x15-16x17-18x19-20x22-21x23-24x27-25x28-30x32

Serie 12 chiavi fisse a due bocche UNI-ISO 10102 DIN 3110

acciaio al cromo vanadio - satinato - in borsa richiudibile - appendibile

Double open ended wrench set UNI-ISO 10102 DIN 3110



Cod.	Pz./Pcs.		
11402	12	1	2650

Composizione:

6x7-8x9-10x11-12x13-14x15-16x17-18x19-20x22-21x23-24x27-25x28-30x32



Chiavi fisse a due bocche UNI-ISO 10102 DIN 3110

acciaio al cromo vanadio - satinato

Double open ended wrenches DIN 3110

POLLICI





Cod.	mm			
11604	5/16x3/8"	140	10	36
11606	7/16x1/2"	170	10	64
11608	9/16x5/8"	185	10	83
11611	11/16x3/4"	220	10	182
11615	7/8x15/16"	245	5	225
11617	1x1.1/8"	280	5	430

Chiavi combinate UNI - ISO 7738 DIN 3113 "OMMAITALY"

acciaio al cromo vanadio - cromate

Combination wrenches DIN 3113 "OMMAITALY"



Cod.	mm			
13001	6	100	10	15
13002	7	110	10	20
13003	8	120	10	25
13004	9	130	10	30
13005	10	140	10	35
13006	11	150	10	45
13007	12	160	10	50
13008	13	170	10	65
13009	14	180	10	70
13010	15	190	10	85
13011	16	200	10	85
13012	17	210	10	105
13013	18	220	10	115
13014	19	232	10	150
13015	20	250	10	150
13016	21	250	10	210
13017	22	270	10	210
13019	24	270	5	270
13022	27	310	5	385
13025	30	340	5	485
13026	32	370	5	530
13028	36	450	1	891
13030	41	480	1	1276
13031	46	500	1	1555
13032	50	520	1	1920





Serie 12 chiavi combinate UNI-ISO 7738 DIN 3113 "OMMA Italy"

acciaio al cromo vanadio - cromate - in borsa richiudibile - appendibile

Combination wrench set UNI-ISO 7738 DIN 3113 "OMMA Italy"



Cod.	Pz./Pcs.		
13101	12	1	955

Composizione:

6-7-8-9-10-11-12-13-14-17-19-22



Serie 17 chiavi combinate UNI-ISO 7738 DIN 3113 "OMMA Italy"
acciaio al cromo vanadio - cromate - in borsa richiudibile - appendibile
Combination wrench set UNI-ISO 7738 DIN 3113 "OMMA Italy"



Cod.	Pz./Pcs.		
13102	17	1	1710



Composizione:
6-7-8-9-10-11-12-13-14-15-16-17-18-19-20-21-22

Serie 17 chiavi combinate UNI - ISO 7738 DIN 3113 "OMMAITALY"
acciaio al cromo vanadio - cromate
Combination wrench set DIN 3113 "OMMAITALY"



Cod.	Pz./Pcs.		
13300	17	1	1510

Composizione:
6-7-8-9-10-11-12-13-14-15-16-17-18-19-20-21-22

Serie 21 chiavi combinate UNI - ISO 7738 DIN 3113 "OMMAITALY"
acciaio al cromo vanadio - cromate
Combination wrench set DIN 3113 "OMMAITALY"



Cod.	Pz./Pcs.		
13400	21	1	3200

Composizione:
6-7-8-9-10-11-12-13-14-15-16-17-18-19-20-21-22-24-27-30-32

Chiavi combinate UNI - ISO 7738 DIN 3113
acciaio al cromo vanadio - satinato
Combination wrenches DIN 3113



Cod.	mm			
13501	6	100	10	15
13502	7	110	10	20
13503	8	120	10	25
13504	9	130	10	30
13505	10	140	10	35
13506	11	150	10	45
13507	12	160	10	50
13508	13	170	10	65
13509	14	180	10	70
13510	15	190	10	85
13511	16	200	10	85
13512	17	210	10	105
13513	18	220	10	115
13514	19	230	10	150
13515	20	240	10	150
13516	21	250	10	210
13517	22	260	5	210
13518	23	270	5	270
13519	24	280	5	385
13520	25	290	5	485
13521	26	300	5	530
13522	27	310	5	530
13523	28	320	5	530
13524	29	330	5	530
13525	30	340	5	530
13526	32	360	5	530

Serie 12 chiavi combinate UNI-ISO 7738 DIN 3113
acciaio al cromo vanadio - satinato - in borsa richiudibile - appendibile
Combination wrench set UNI-ISO 7738 DIN 3113



Cod.	Pz./Pcs.		
13401	12	1	955



Composizione:
6-7-8-9-10-11-12-13-14-17-19-22

Serie 8 chiavi poligonali doppia curva DIN 838
acciaio al cromo vanadio - satinate
Offset ring wrench set DIN 838



Cod.	Pz./Pcs.		
12520	8	1	1400

Composizione:
6x7-8x9-10x11-12x13-14x15-16x17-18x19-20x22

Serie 12 chiavi poligonali doppia curva DIN 838
acciaio al cromo vanadio - satinate
Offset ring wrench set DIN 838



Cod.	Pz./Pcs.		
12530	12	1	3540

Composizione:
6x7-8x9-10x11-12x13-14x15-16x17-18x19-20x22-21x23-24x27-25x28-30x32

Serie 8 chiavi fisse a due bocche DIN 3110
acciaio al cromo vanadio - cromate
Double open ended wrench set



Cod.	Pz./Pcs.		
11540	8	1	880

Composizione:
6x7-8x9-10x11-12x13-14x15-16x17-18x19-20x22

LINEA BASIC

Serie 12 chiavi fisse a due bocche DIN 3110
acciaio al cromo vanadio - cromate
Double open ended wrench set



Cod.	Pz./Pcs.		
11542	12	1	2250

Composizione:
6x7-8x9-10x11-12x13-14x15-16x17-18x19-20x22-21x23-24x27-25x28-30x32

LINEA BASIC

Serie 12 chiavi combinate DIN 3113
acciaio al cromo vanadio - cromate
Combination wrench set DIN 3113



Cod.	Pz./Pcs.		
13540/S12	12	1	833

Composizione:
6-7-8-9-10-11-12-13-14-17-19-22

LINEA BASIC

Serie 17 chiavi combinate DIN 3113
acciaio al cromo vanadio - cromate
Combination wrench set DIN 3113



Cod.	Pz./Pcs.		
13540/S17	17	1	1660



Composizione:
6-7-8-9-10-11-12-13-14-15-16-17-18-19-20-21-22

LINEA BASIC

Serie 25 chiavi combinate DIN 3113

acciaio al cromo vanadio - cromate
Combination wrench set DIN 3113



Cod.	Pz./Pcs.		
13550/S25	25	1	833

LINEA BASIC



Composizione:

6-7-8-9-10-11-12-13-14-15-16-17-18-19-20-21-22-23-24-25-26-27-28-30-32

Chiavi fisse a una bocca DIN 894

acciaio speciale - zincate
Single open ended wrenches DIN 894





Cod.	mm		
14001ZC	6	75	10 10
14002ZC	7	80	10 10
14003ZC	8	90	10 18
14004ZC	9	100	10 20
14005ZC	10	110	10 23
14006ZC	11	120	10 40
14007ZC	12	125	10 40
14008ZC	13	130	10 45
14009ZC	14	140	10 45
14010ZC	15	150	10 65
14050ZC	16	160	10 70
14011ZC	17	160	10 70
14012ZC	18	170	10 95
14013ZC	19	180	10 100
14014ZC	22	200	5 150
14015ZC	24	220	5 180
14016ZC	27	240	5 235
14016ZC/28	28	230	5 171
14017ZC	30	260	5 315
14018ZC	32	280	5 340
14060ZC	34	290	5 340
14019ZC	36	320	5 455
14020ZC	38	330	5 540
14022ZC	41	350	5 580
14064ZC	42	350	5 580
14064ZC/45	45	375	5 888
14023ZC	46	380	5 750
14023ZC/47	47	370	5 849
14024ZC	50	420	2 950
14025ZC	55	460	2 1160
14026ZC	60	500	2 1605
14027ZC	65	540	2 1705
14028ZC	70	540	1 2500
14029ZC	75	580	1 3500
14030ZC	80	620	1 3500
14031ZC	85	670	1 4780
14032ZC	90	700	1 5450
14033ZC	95	730	1 5950
14034ZC	100	760	1 7800
14035ZC	105	1000	1 8000
14036ZC	110	1000	1 8230
14037ZC	115	1000	1 7820
14038ZC	120	1000	1 8240
14039ZC	125	1000	1 7800
14040ZC	130	1000	1 8230
14041ZC	135	1000	1 9000

LINEA BASIC

Chiavi fisse a due bocche DIN 895

acciaio speciale - zincate
Double open ended wrenches DIN 895





Cod.	mm			
15001ZC	6x7	90	10	18
15001ZC/8	7x8	105	10	20
15001ZC/9	7x9	105	10	21
15002ZC	8x9	105	10	25
15003ZC	8x10	110	10	30
15003ZC/10	9x10	110	10	30
15004ZC	10x11	120	10	38
15005ZC	10x12	125	10	45
15006ZC	10x13	130	10	45
15006ZC/14	10x14	135	10	41
15007ZC	11x13	135	10	45
15007ZC/14	11x14	135	10	41
15008ZC	12x13	137	10	56
15009ZC	12x14	140	10	55
15010ZC	13x14	146	10	55
15011ZC	13x15	153	10	70
15012ZC	13x17	158	10	75
15013ZC	14x15	158	10	80
15014ZC	14x17	160	10	80
15015ZC	16x17	174	10	100
15016ZC	17x19	192	10	130
15017ZC	18x19	192	10	140
15018ZC	19x22	200	10	165
15019ZC	19x24	224	5	220
15020ZC	20x22	210	5	185
15021ZC	21x23	223	5	200
15022ZC	22x24	230	5	240
15022ZC/27	22x27	230	5	248
15023ZC	24x26	240	5	275
15024ZC	24x27	240	5	280
15025ZC	24x30	264	5	400
15026ZC	25x28	252	5	330
15027ZC	27x30	268	5	420
15028ZC	27x32	268	5	420
15029ZC	30x32	282	5	430
15030ZC	30x36	305	5	505
15031ZC	32x36	324	5	640
15032ZC	34x38	326	5	720
15033ZC	36x41	350	5	850
15034ZC	41x46	390	5	1150
15035ZC	46x50	420	5	1340
15036ZC	50x55	460	5	2100
15037ZC	55x60	500	2	2260
15038ZC	65x70	580	1	2700
15039ZC	75x80	640	1	4080

LINEA BASIC

Serie 8 chiavi fisse a due bocche DIN 895

acciaio speciale - zincate
Double open ended wrench set DIN 895



Cod.	Pz./Pcs.		
15100ZC	8	1	640

LINEA BASIC

Composizione:

6x7-8x9-10x11-12x13-14x15-16x17-18x19-20x22

Chiavi a cricchetto reversibili piegate a 90°

72 denti, impronta SPLINE, acciaio cromo vanadio

Double SPLINE reversible combination wrenches



Cod.	mm			
AT2232	10x11	130	1	98
AT2233	12x14	155	1	125
AT2234	13x14	155	1	125
AT2235	15x17	200	1	130
AT2236	16x17	200	1	225

Chiavi poligonali doppie a cricchetto piegate

acciaio al cromo vanadio - cromate

Bent reversible ratchets



Cod.	mm			
13800	7x8	136	1	80
13801	9x10	144	1	95
13802	11x12	170	1	150
13803	13x14	176	1	160
13804	15x17	208	1	265
13805	16x18	208	1	265
13806	19x21	238	1	305

Chiavi poligonali doppie a cricchetto diritte

acciaio al cromo vanadio - cromate

Flat reversible ratchets



Cod.	mm			
13810	7x8	136	1	80
13811	9x10	144	1	95
13812	11x12	170	1	150
13813	13x14	176	1	160
13814	15x17	208	1	265
13815	16x18	208	1	265
13816	19x21	238	1	305

Chiavi a bussola poligonali doppie snodate

acciaio al cromo vanadio - cromate

Double flexible socket wrenches 12 points



Cod.	mm			
25302	8x9	195	1	85
25303	10x11	215	1	115
25304	12x13	226	1	165
25305	14x15	235	1	220
25306	16x17	250	1	280
25307	18x19	270	1	380

Chiavi fisse una bocca a battere DIN 133

acciaio al cromo - brunite

Slugging open ended wrenches DIN 133



Cod.	mm			
15301	24	160	2	300
15302	27	180	2	360
15303	30	190	2	550
15304	32	195	2	550
15305	36	210	1	850
15306	41	230	1	1040
15307	46	250	1	1390
15308	50	275	1	1640
15309	55	305	1	2250
15310	60	315	1	2540
15311	65	345	1	3640
15312	70	370	1	4000
15313	75	385	1	5000
15314	80	400	1	5020
15315	85	410	1	6980
15316	90	445	1	8320
15317	95	455	1	10000

Chiavi poligonali una bocca a battere DIN 7444

acciaio al cromo - brunite

Slugging ring wrenches DIN 7444



Cod.	mm			
16002	27	175	2	320
16003	30	193	2	440
16004	32	193	2	470
16005	36	213	2	700
16006	41	213	1	790
16007	46	240	1	975
16008	50	245	1	980
16009	55	270	1	1600
16010	60	273	1	1750
16011	65	300	1	2180
16012	70	305	1	2400
16013	75	330	1	3000
16014	80	350	1	3300
16015	85	360	1	4860
16016	90	380	1	5400
16017	95	400	1	6300
16018	100	403	1	6900

Chiavi a cricchetto per ponteggi

acciaio al cromo vanadio - satinare bussola fosfatata

Reversible ratchet ring wrenches for schaffolds



Cod.	mm			
16102	21x22	315	2	440

Chiavi regolabili a rullino - scala millimetrata
acciaio al cromo - cromate
Adjustable wrenches

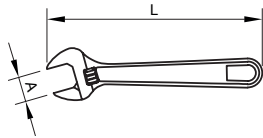

Cod.	A	L		
18101	19	150 / 6"	1	166
18102	24	200 / 8"	1	275
18103	30	250 / 10"	1	498
18104	34	300 / 12"	1	799

Chiavi regolabili a rullino
acciaio al carbonio - cromate - manici platinicati
Adjustable wrenches



Cod.		A		
18001	150 / 6"	19	1	120
18002	200 / 8"	24	1	220
18003	250 / 10"	30	1	400
18004	300 / 12"	34	1	650

LINEA BASIC

Chiavi a settore snodate nasello quadro
acciaio al cromo vanadio - cromate
Adjustable square hook wrenches

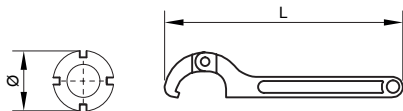

Cod.	Ø	L		
17050	15/35	170	1	100
17051	35/50	210	1	160
17052	50/80	280	1	380
17053	80/120	345	1	700
17054	120/180	475	1	1500

Chiavi a settore nasello quadro DIN 1810
acciaio al cromo molibdeno - cromate
Square hook wrenches DIN 1810

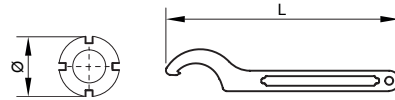

Cod.	Ø	L		
17003	22/25/28	136	1	50
17004	30/32	136	1	50
17005	34/36/38	170	1	95
17006	40/42	170	1	95
17007	45/50	205	1	150
17008	52/55	205	1	150
17009	58/62/65	240	1	220
17010	68/70/75	240	1	220
17011	80/85/90	280	1	370
17011A	92/95	280	1	370
17012	98/100	280	1	370
17013	105/110/115	320	1	740
17014	120/125/130	320	1	740
17015	135/145	380	1	1100
17016	155/165	380	1	1120
17017	180/195	380	1	1140

17018*	205/220	480	1	1430
17019*	230/245	570	1	2180
17020*	260/270	570	1	2300
17021*	280/300	650	1	3380
17023*	320/345	700	1	4191

* Acciaio - cromate

A richiesta si producono fino a mm 500

Chiavi a settore nasello tondo DIN 1810
acciaio al cromo molibdeno - cromate
Round hook wrenches DIN 1810

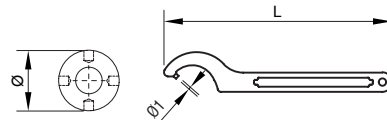

Cod.	Ø	L	Ø1		
17103	25/28	136	2,8	1	50
17104	30/32	136	3,8	1	50
17105	34/36	170	3,8	1	95
17106	40/42	170	3,8	1	95
17107	45/50	205	4,8	1	150
17108	52/55	205	4,8	1	150
17109	58/62	240	4,8	1	220
17110	68/75	240	5,8	1	220
17111	80/90	280	5,8	1	370
17112	95/100	280	7,8	1	370
17113	110/115	320	7,8	1	740
17114	120/130	330	7,8	1	740
17115	135/145	380	7,8	1	1100
17116	155/165	380	7,8	1	1120
17117	180/195	380	9,8	1	1140

Chiavi a settore snodate nasello tondo

acciaio al cromo vanadio - cromate

Adjustable round hook wrenches

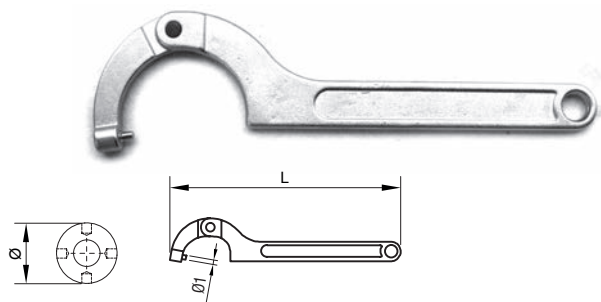

Cod.	Ø	Filetto	Ø1	Pinza	Denti	Ø1	Ø2
17122	15/35	170	2,8	1	100		
17123	35/50	210	3,8	1	160		
17124	50/80	280	4,8	1	380		
17125	80/120	345	5,8	1	700		
17126	120/180	475	7,8	1	1500		

Nasello di ricambio

per chiavi a settore snodate cod. 17122 ÷ 17126

Spare round hook pin for adjustable round hook wrenches



Cod.	Ø	Ø1	Pinza	Denti	Ø1	Ø2
17122R	15/35	2,8	1	5		
17123R	35/50	3,8	1	5		
17124R	50/80	4,8	1	6		
17125R	80/120	5,8	1	6		
17126R	120/180	7,8	1	8		

Chiavi per ghiera mandrini a quattro denti

manico plastificato - zincate

Hook wrenches

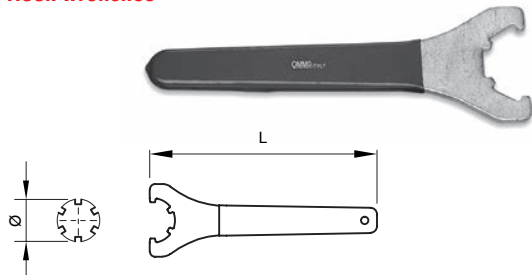

Cod.	Ø	Pinza	L	Pinza	Denti	Ø1	Ø2
17029	32	16	160	1	140		
17030	35	20	180	1	180		
17031	42	25	205	1	220		
17032	50	32	250	1	380		
17033	63	40	280	1	500		
17034	78	50	350	1	760		

Chiavi per ghiera mandrini a quattro denti mini

manico plastificato - brunite

Hook wrenches



Cod.	Ghiera	Filetto	Pinza	Denti	Ø1	Ø2
17041	8	75	1	20		
17042	11	95	1	35		
17043	16	120	1	50		
17044	20	130	1	65		
17045	25	145	1	85		

Chiavi per ghiera "KM" denti esterni

acciaio al carbonio - brunite

"KM" hook wrenches external teeth

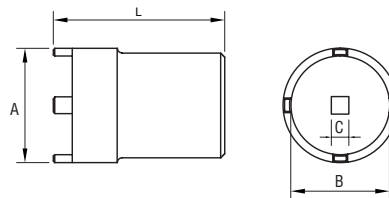

Cod.	Ø Ghiera	Filetto	A	B	C	L	Denti	Pinza	Ø1	Ø2
17130/0	18	10x0,75	23,5	15,5	3/8"	60	4	1	112	
17130/1	22	12x1	27,5	18,5	3/8"	60	4	1	165	
17130/2	25	15x1	30	21,5	1/2"	60	4	1	168	
17130/3	28	17x1	33	24,5	1/2"	60	4	1	200	
17130/4	32	20x1	38	28,5	1/2"	60	4	1	230	
17130/5	38	25x1,5	44	34,5	3/4"	60	4	1	280	
17130/6	45	30x1,5	51	41,5	3/4"	60	4	1	410	
17130/7	52	35x1,5	58	48,5	3/4"	60	4	1	550	
17130/8	58	40x1,5	64	53,5	3/4"	60	4	1	665	
17130/9	65	45x1,5	69	60,5	3/4"	60	4	1	760	
17130/10	70	50x1,5	74	65,5	3/4"	60	4	1	840	
17130/11	75	55x2	79	69,5	3/4"	60	4	1	870	
17130/12	80	60x2	84	74,5	1"	60	4	1	965	
17130/13	85	65x2	90	79,5	1"	60	4	1	1100	
17130/14	92	70x2	97	85,5	1"	60	4	1	1300	

Chiavi per ghiera "GU" denti esterni

acciaio al carbonio - brunite

"GU" hook wrenches external teeth

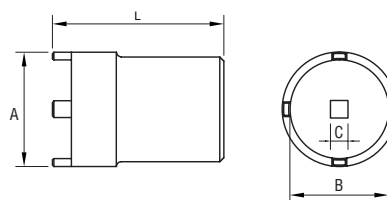

Cod.	Ø Ghiera	Filetto	A	B	C	L	Denti	Pinza	Ø1	Ø2
17131/0	18	10x0,75	23,5	15,5	3/8"	60	4	1	115	
17131/1	22	12x1	27,5	18,5	3/8"	60	4	1	170	
17131/2	25	15x1	30	21,5	1/2"	60	4	1	180	
17131/3	28	17x1	33	24,5	1/2"	60	4	1	195	
17131/4	32	20x1	38	27,5	1/2"	60	4	1	230	
17131/5	38	25x1,5	44	33,5	3/4"	60	4	1	285	
17131/6	44	30x1,5	50	38,5	3/4"	60	4	1	385	
17131/7	50	35x1,5	54,5	44,5	3/4"	60	4	1	440	
17131/8	56	40x1,5	60	50,5	3/4"	60	4	1	540	
17131/9	62	45x1,5	67	55,5	3/4"	60	4	1	685	
17131/10	68	50x1,5	73	61,5	1"	60	4	1	880	
17131/11	75	55x2	80	68,5	3/4"	60	6	1	950	
17131/12	80	60x2	84,5	73,5	1"	60	6	1	1255	
17131/13	85	65x2	90	77,5	1"	60	6	1	1120	
17131/14	92	70x2	97	84,5	1"	60	6	1	1310	

Chiavi per ghiera "KM" denti interni
acciaio al carbonio - brunite
"KM" hook wrenches internal teeth

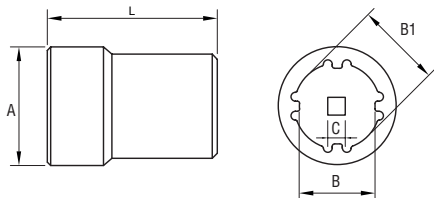

Cod.	Ø Ghiera	Filetto	A	B	C	L	B1	Denti		
17132/0	18	10x0,75	28	15,5	3/8"	60	18,5	4	1	145
17132/1	22	12x1	32	18,5	3/8"	60	22,5	4	1	210
17132/2	25	15x1	34,5	21,5	1/2"	60	25,5	4	1	225
17132/3	28	17x1	39	24,5	1/2"	60	28,5	4	1	270
17132/4	32	20x1	44	28,5	1/2"	60	32,5	4	1	380
17132/5	38	25x1,5	49	34,5	3/4"	60	38,5	4	1	420
17132/6	45	30x1,5	56	41,5	3/4"	60	45,5	4	1	550
17132/7	52	35x1,5	63	48,5	3/4"	60	52,5	4	1	725
17132/8	58	40x1,5	69	53,5	3/4"	60	58,5	4	1	800
17132/9	65	45x1,5	76	60,5	3/4"	60	65,5	4	1	880
17132/10	70	50x1,5	80,5	65,5	1"	60	70,5	4	1	980
17132/11	75	55x2	86	69,5	1"	60	75,5	4	1	1100
17132/12	80	60x2	91	74,5	1"	60	80,5	4	1	1180
17132/13	85	65x2	96	79,5	1"	60	85,5	4	1	1300

Chiavi per ghiera "GU" denti interni
acciaio al carbonio - brunite
"GU" hook wrenches internal teeth

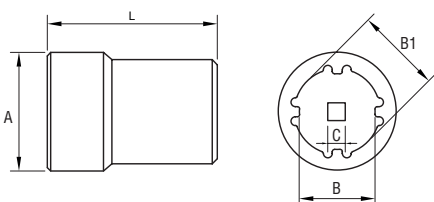

Cod.	Ø Ghiera	Filetto	A	B	C	L	B1	Denti		
17133/0	18	10x0,75	28	15,5	3/8"	60	18,5	4	1	145
17133/1	22	12x1	32	18,5	3/8"	60	21,5	4	1	210
17133/2	25	15x1	34,5	21,5	1/2"	60	24,5	4	1	240
17133/3	28	17x1	39	24,5	1/2"	60	28,5	4	1	270
17133/4	32	20x1	44	27,5	1/2"	60	32,5	4	1	400
17133/5	38	25x1,5	49	33,5	3/4"	60	38,5	4	1	450
17133/6	44	30x1,5	56	38,5	3/4"	60	44,5	4	1	500
17133/7	50	35x1,5	61	44,5	3/4"	60	50,5	4	1	575
17133/8	56	40x1,5	67	50,5	3/4"	60	56,5	4	1	640
17133/9	62	45x1,5	78	55,5	3/4"	60	62,5	4	1	960
17133/10	68	50x1,5	84	61,5	3/4"	60	68,5	4	1	1150
17133/11	75	55x2	92	68,5	1"	60	75,5	6	1	1350
17133/12	80	60x2	96	73,5	1"	60	80,5	6	1	1380
17133/13	85	65x2	99	77,5	1"	60	85,5	6	1	1470

Chiavi a tubo doppie diritte esagonali tipo pesante
acciaio al cromo vanadio - cromate
Heavy tubular box wrenches



Cod.				
28001A	6x7	110	20	40
28004A	8x9	110	20	57
28007A	10x11	125	20	65
28013A	12x13	140	10	105
28016A	14x15	145	10	145
28018A	16x17	150	6	178
28020A	18x19	165	6	280
28022A	20x22	175	6	300
28023A	21x23	185	6	370
28025A	24x26	195	4	460
28028A	25x28	200	4	510
28029A	27x29	210	4	555
28031A	30x32	210	4	825

Asta di manovra per chiavi a tubo cod. 28001A ÷ 28020A
Handle for heavy tubular box wrenches



Cod.	Ø			
A6-19	3-4-5-6-8	165	1	43

Asta di manovra per chiavi a tubo cod. 28022A ÷ 28031A
Handle for heavy tubular box wrenches



Cod.	Ø			
A20-32	9-12	210	1	168

Serie 8 chiavi a tubo doppie diritte esagonali tipo pesante completa di aste di manovra
acciaio al carbonio - cromate
8 pcs. heavy tubular box wrench set



Cod.	Pz./Pcs.		
28000A/8	10	1	1450

Composizione:
6x7-8x9-10x11-12x13-14x15-16x17-18x19-20x22
A6-19 e A20-32

Chiavi a pipa doppie esagonali poligonali con foro passante
acciaio al cromo vanadio - cromate
Double ended socket through wrenches



Cod.	⊗ x ⊕	📏	🔧	⚠️
28108	8x8	114	5	90
28109	9x9	125	5	96
28110	10x10	129	5	112
28111	11x11	136	5	120
28112	12x12	144	5	165
28113	13x13	152	5	185
28114	14x14	160	5	200
28115	15x15	175	5	215
28116	16x16	185	5	246
28117	17x17	185	5	310
28118	18x18	205	5	360
28119	19x19	205	5	385
28120	20x20	220	5	470
28121	21x21	220	5	550
28122	22x22	230	5	550
28123	23x23	240	5	695
28124	24x24	250	2	810
28125	25x25	260	2	880
28126	26x26	270	2	940
28127	27x27	280	2	956
28128	28x28	295	2	1035
28130	30x30	315	2	1265
28132	32x32	335	2	1495

Serie 7 chiavi a pipa doppie esagonali poligonali con foro passante
acciaio al cromo vanadio - cromate - in borsa richiudibile
8 pcs. double ended socket through wrench set



Cod.	Pz./Pcs.	🔧	⚠️
28100/7	7	1	1185

Composizione:
mm 8x8 - 9x9 - 10x10 - 12x12 - 13x13 - 14x14 - 17x17
Busta: BGRI

Serie 8 chiavi a pipa doppie esagonali poligonali con foro passante
acciaio al cromo vanadio - cromate
8 pcs. double ended socket through wrench set



Cod.	Pz./Pcs.	🔧	⚠️
28100/8	8	1	1600

Composizione:
mm 8-9-10-11-13-14-17-19

Serie 12 chiavi a pipa doppie esagonali poligonali con foro passante
acciaio al cromo vanadio - cromate
12 pcs. double ended socket through wrench set



Cod.	Pz./Pcs.	🔧	⚠️
28100/12	12	1	2400

Composizione:
mm 6-7-8-9-10-11-12-13-14-17-19-22

Chiavi a pipa esagonali per morse
acciaio al cromo vanadio - cromate
Ended socket wrenches for vices



Cod.	⊙	▧	▩	⚙
28095	19	260	1	510
28096	22	260	1	550

Aste di manovra per chiavi a tubo
Handles for heavy tubular box wrenches



Cod.	mm	L	per cod.	▧	⚙
28050	4-6	120	28001÷28007	1	29
28051	7-8	140	28013÷28020	1	55

LINEA BASIC

Chiavi a tubo doppie
bocche esagonali zincate
Tubular box wrenches



Cod.	⊙x⊙	L	∅ mm foro	▧	⚙
28001	6x7	90	4,2	1	25
28004	8x9	95	6,2	1	50
28005	8x10	95	6,2	1	50
28007	10x11	105	6,2	1	70
28013	12x13	110	7,2	1	85
28014	12x14	110	7,2	1	85
28015	13x17	125	7,2	1	120
28016	14x15	110	7,2	1	95
28018	16x17	125	7,2	1	110
28019	17x19	130	8,5	1	145
28020	18x19	135	8,5	1	145
28021	19x22	135	10,3	1	160
28022	20x22	135	10,3	1	160
28023	21x23	140	10,3	1	160
28024	22x24	130	10,3	1	150
28025	24x26	145	10,3	1	185
28027	24x27	150	12	1	250
28028	25x28	160	12	1	300
28029	27x29	165	12	1	315
28031	30x32	165	14	1	365
28032	32x36	170	14	1	400
28033	35x38	180	14	1	460
28034	36x41	180	14	1	480
28035	44x46	190	16,5	1	560
28036	48x50	190	16,5	1	560
28038	50x55	200	17,5	1	690
28039	55x55	200	17,5	1	690
28040	55x60	200	17,5	1	740

LINEA BASIC

Chiavi a pipa doppie
bocche esagonali zincate
Bent tubular box wrenches

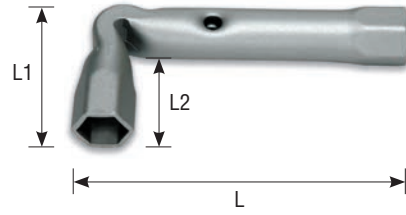

LINEA BASIC

Cod.	⊙x⊙	L	L1	L2	∅ mm foro	▧	⚙
28201	6x6	80	32	20	4,2	1	25
28202	7x7	85	32	20	4,2	1	30
28203	8x8	90	40	23	5,2	1	65
28204	9x9	95	40	23	5,2	1	65
28205	10x10	95	40	23	5,2	1	65
28206	11x11	105	45	30	6,2	1	85
28207	12x12	105	45	30	6,2	1	100
28208	13x13	110	50	30	6,2	1	110
28209	14x14	115	55	33	6,2	1	110
28210	15x15	115	60	33	6,5	1	110
28211	16x16	135	60	40	7,2	1	165
28212	17x17	135	60	40	7,2	1	165
28213	18x18	135	65	40	7,2	1	165
28214	19x19	140	70	40	7,2	1	165
28215	20x20	140	70	40	7,2	1	210
28216	21x21	145	70	40	7,2	1	210
28217	22x22	145	75	40	7,2	1	210
28218	23x23	145	75	40	9,3	1	225
28219	24x24	145	80	40	9,3	1	225

Chiavi maschio esagonali piegate DIN 911
acciaio al cromo vanadio - nichelate
Hexagonal wrenches DIN 911

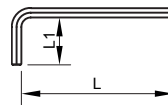

Cod.	⊙	LxL1	▧	⚙
31001	1,5	45x14	10	1
31002	2	50x16	10	2
31003	2,5	56x18	10	3
31004	3	66x20	10	4
31005	3,5	67x22	10	5
31006	4	72x25	10	11
31007	4,5	78x25	10	14
31008	5	80x28	10	18
31010	6	90x32	10	30
31011	7	100x34	5	43
31012	8	100x35	5	60
31013	9	106x38	5	80
31014	10	112x40	5	103
31015	12	130x45	2	165
31016	14	148x54	2	256
31017	17	159x60	2	441
31018	19	176x65	2	598
31019	22	186x74	1	870
31020	24	196x75	1	1121

Serie 8 chiavi maschio esagonale piegate con anello
acciaio al cromo vanadio - nichelate
Hexagonal wrench set



Cod.	Pz./Pcs.		
31200	8	1	105

Composizione:
1,5-2-2,5-3-4-5-5,5-6

Serie 10 chiavi maschio esagonale piegate con anello
acciaio al cromo vanadio - nichelate
Hexagonal wrench set



Cod.	Pz./Pcs.		
31210	10	1	265

Composizione:
1,5-2-2,5-3-4-5-5,5-6-8-10

Serie 8 chiavi esagonali piegate in busta plastica
acciaio al cromo vanadio - nichelate
Hexagonal wrench set in PVC bag



Cod.	Pz./Pcs.		
31000/8	8	1	90

Composizione:
1,5-2-2,5-3-4-4,5-5-6

Serie 10 chiavi esagonali piegate in busta plastica
acciaio al cromo vanadio - nichelate
Hexagonal wrench set in PVC bag



Cod.	Pz./Pcs.		
31000/10	10	1	260

Composizione:
1,5-2-2,5-3-4-4,5-5-6-8-10

Serie 14 chiavi maschio esagonale piegate in cassetta plastica
acciaio al cromo vanadio - nichelate
14 pcs hexagonal wrench set

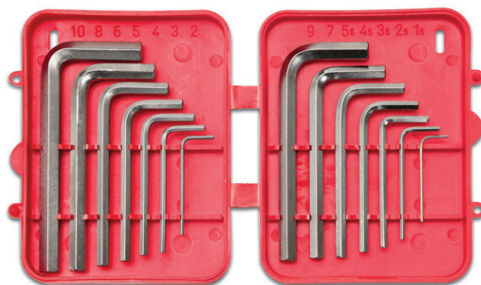

Cod.	Pz./Pcs.		
31000/14	14	1	443

Composizione:
1,5-2-2,5-3-3,5-4-4,5-5-5,5-6-7-8-9-10

* IN ESAURIMENTO

Serie 9 chiavi maschio esagonale piegate
acciaio al cromo vanadio - cromate
9 pcs hexagonal wrench set



Cod.	Pz./Pcs.		
31000/9	9	1	260

Composizione:
1,5-2-2,5-3-4-5-6-8-10

Chiavi maschio esagonale piegate ricavate da tondo
esagoni stampati - acciaio al carbonio, zincate
Hexagonal wrenches



Cod.		L x L1		
31103TD	2	50x18	3000	2
31104TD	2,5	54x20	3000	3
31105TD	3	63x23	2500	5
31107TD	4	74x28	1300	11
31109TD	5	77x32	500	18
31111TD	6	94x36	500	32

LINEA BASIC

Chiavi maschio esagonale piegate
acciaio inox
Hexagonal wrenches



ACCIAIO INOX

Cod.	●	LxL1		
31001INX	1,5	45x13	10	3
31002INX	2	50x16	10	4
31003INX	2,5	55x17	10	5
31004INX	3	62x20	10	7
31006INX	4	70x25	10	12
31008INX	5	80x26	10	20
31010INX	6	89x30	5	31
31012INX	8	97x35	5	59
31014INX	10	109x40	5	103

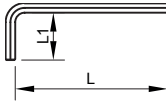

Serie 9 chiavi maschio esagonale piegate
acciaio inox
9 pcs Hexagonal wrench set



ACCIAIO INOX

Cod.	●	Pz./Pcs.		
31000INX/9	9	1	255	

Composizione:
1,5-2-2,5-3-4-5-6-8-10

Chiavi maschio esagonale piegate tipo lungo
acciaio al cromo vanadio - brunite
Hexagonal long wrenches



Cod.	●	LxL1		
31052	2	100x16	10	2
31053	2,5	112x16	10	3
31054	3	125x20	10	7
31055	3,5	128x25	10	12
31056	4	140x25	10	14
31057	4,5	147x27	10	23
31058	5	160x25	10	25
31060	6	180x30	10	41
31061	7	190x35	5	61
31062	8	200x35	5	84
31064	10	225x40	5	175
31065	12	245x43	2	275
31066	14	280x54	2	330

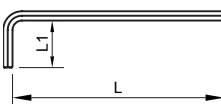

Serie 9 chiavi maschio esagonale piegate tipo lungo
acciaio al cromo vanadio - brunite
9 pcs Hexagonal long wrench set



Cod.	●	Pz./Pcs.		
31050/9	9	1	380	

Composizione:
1,5-2-2,5-3-4-5-6-8-10

Chiavi maschio esagonale piegate tipo lungo con 2 fori
acciaio al cromo vanadio - brunite
Hexagonal long tamper wrenches



Cod.	●	LxL1		
31002F	2	83x16	10	3
31003F	2,5	90x18	10	4
31004F	3	98x20	10	7
31006F	4	106x24	10	13
31008F	5	118x28	10	24
31010F	6	137x32	5	40
31012F	8	156x36	5	81

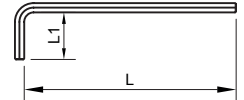

Serie 7 chiavi maschio esagonale piegate tipo lungo con 2 fori
acciaio al cromo vanadio - brunite
7 pcs Hexagonal long tamper wrench set



Cod.	●	Pz./Pcs.		
31000F/7	7	1	346	

Composizione:
2,5-3-4-5-6-8-10

Serie 9 chiavi maschio esagonali piegate in pollici
acciaio al cromo vanadio - brunite
9 pcs Inch hexagonal wrench set

POLLICI



Cod.	●	Pz./Pcs.		
31070/9	9	1	281	

Composizione:
1/16"-5/64"-3/32"-1/8"-5/32"-3/16"-1/4"-5/16"-3/8"

Chiavi maschio esagonale piegate con testa sferica
acciaio al cromo vanadio - brunite
Hexagonal ball point wrenches

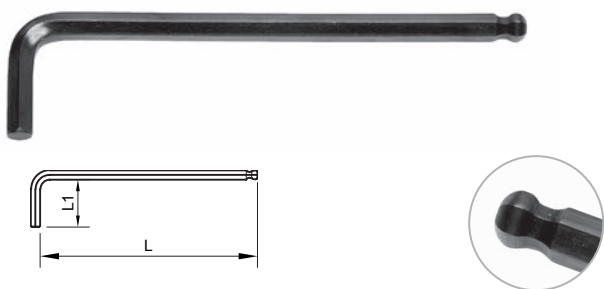

Cod.	●	LxL1	📏	⚙️
32101x1,5	1,5	77x14	10	1,4
32101x2	2	83x16	10	2
32101x2,5	2,5	90x17	10	4
32101x3	3	98x20	10	7
32101x4	4	105x24	10	14
32101x5	5	114x24	10	25
32101x6	6	136x31	5	41
32101x8	8	153x31	5	84
32101x10	10	170x33	5	145

Serie 7 chiavi due teste maschio esagonale piegate con testa sferica
acciaio al cromo vanadio - brunite
7 pcs hexagonal ball point wrench set



Cod.	Pz./Pcs.	📏	⚙️
32101	7	1	310

Composizione:
2,5-3-4-5-6-8-10

Chiavi maschio esagonale piegate tipo lungo con testa sferica
acciaio al cromo vanadio - brunite
Long type hexagonal ball point wrenches

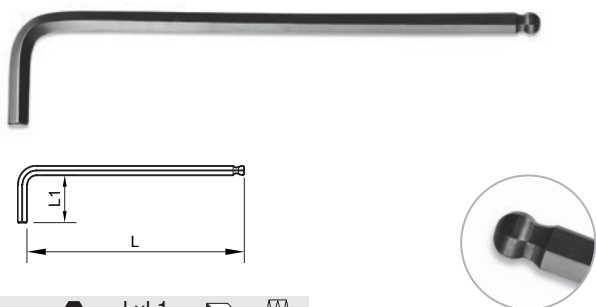

Cod.	●	LxL1	📏	⚙️
32102x2,5	2,5	112x18	5	5
32102x3	3	126x20	5	9
32102x4	4	140x25	5	17
32102x5	5	160x28	5	31
32102x6	6	180x32	5	50
32102x8	8	200x35	5	102
32102x10	10	224x40	5	178

Serie 9 chiavi maschio esagonali piegate tipo lungo COLORATE con testa sferica
acciaio al silicio - colorate
9 pcs coloured hexagonal ball point wrench set



Cod.	Pz./Pcs.	📏	⚙️
32107	9	1	450

Composizione:
1,5-2-2,5-3-4-5-6-8-10

Serie 9 chiavi maschio esagonale piegate con testa sferica angolare adatta ad una miglior presa
acciaio al cromo vanadio - brunite
9 pcs hexagonal ball point wrench set with angular ball point suitable for better grip



Cod.	Pz./Pcs.	📏	⚙️
32105	9	1	342

Composizione:
1,5-2-2,5-3-4-5-6-8-10

Serie 9 chiavi maschio esagonale piegate con un lato lungo a testa sferica ed un lato extracorto
acciaio al cromo vanadio - cromate
9 pcs hexagonal ball point wrench set with ball point one long side and one extrashort side

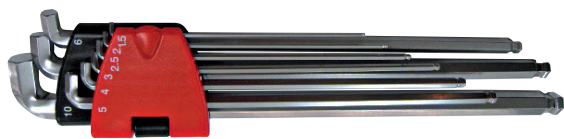

Cod.	Pz./Pcs.		
32104	9	1	430

Composizione:
1,5-2-2,5-3-4-5-6-8-10

Chiavi maschio piegate per viti TX
acciaio al cromo vanadio - brunite
Star head wrenches

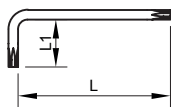

Cod.		LxL1		
34306	T06	66x16	5	2
34307	T07	72x16	5	3
34308	T08	77x16	5	3
34309	T09	80x16	5	4
34310	T10	86x18	5	6
34315	T15	90x18	5	9
34320	T20	95x18	5	12
34325	T25	100x20	5	16
34327	T27	103x20	5	24
34330	T30	113x24	5	31
34340	T40	125x25	5	46
34345	T45	132x30	5	64
34350	T50	150x32	5	90

Serie 9 chiavi maschio piegate per viti TX
acciaio al cromo vanadio - brunite
9 pcs Star head wrench set



Cod.	Pz./Pcs.		
34300/9	9	1	320

Composizione:
T10-T15-T20-T25-T27-T30-T40-T45-T50

Chiavi maschio piegate per viti TX con 2 fori
acciaio al cromo vanadio - brunite
Tamper star head wrenches

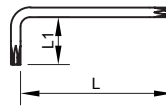

Cod.		LxL1		
34306F	T06	66x16	5	2
34307F	T07	72x16	5	3
34308F	T08	77x16	5	3
34309F	T09	80x16	5	4
34310F	T10	86x18	5	6
34315F	T15	90x18	5	9
34320F	T20	95x18	5	12
34325F	T25	100x20	5	16
34327F	T27	103x20	5	24
34330F	T30	113x24	5	31
34340F	T40	125x25	5	46

Serie 9 chiavi maschio piegate per viti TX con 2 fori
acciaio al cromo vanadio - brunite
9 pcs tamper head wrench set



Cod.	Pz./Pcs.		
34300F/9	9	1	342

Composizione:
T10-T15-T20-T25-T27-T30-T40-T45-T50

Chiavi maschio piegate per viti XZN
acciaio al cromo vanadio - cromate
XZN head wrenches

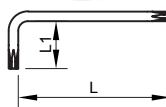

Cod.		L1xL2		
32103x5	M5	72x24	1	14
32103x6	M6	76x26	1	22
32103x8	M8	82x28	1	42
32103x10	M10	93x31	1	76
32103x12	M12	106x34	1	113